



DC COMPONENTS CO., LTD.
RECTIFIER SPECIALISTS

DLQ4148
DLQ4448
DLQ4150
DLQ4151

TECHNICAL SPECIFICATIONS OF SURFACE MOUNT SWITCHING DIODES

VOLTAGE RANGE - 50 to 100 Volts

POWER - 500 mWatts

FEATURES

- * Fast switching speed
- * Silicon epitaxial planar diodes
- * Low power loss, high efficiency
- * Low leakage
- * High surge forward current capability

MECHANICAL DATA

- * Case: Glass sealed case
- * Terminals: Solder plated, solderable per MIL-STD-202E, Method 208 guaranteed
- * Polarity: Color band denotes cathode end
- * Mounting position: Any
- * Weight: 0.05 grams

MAXIMUM RATINGS AND ELECTRICAL CHARACTERISTICS

Ratings at 25°C ambient temperature unless otherwise specified.
Single phase, half wave, 60Hz, resistive or inductive load.
For capacitive load, derate current by 20%.

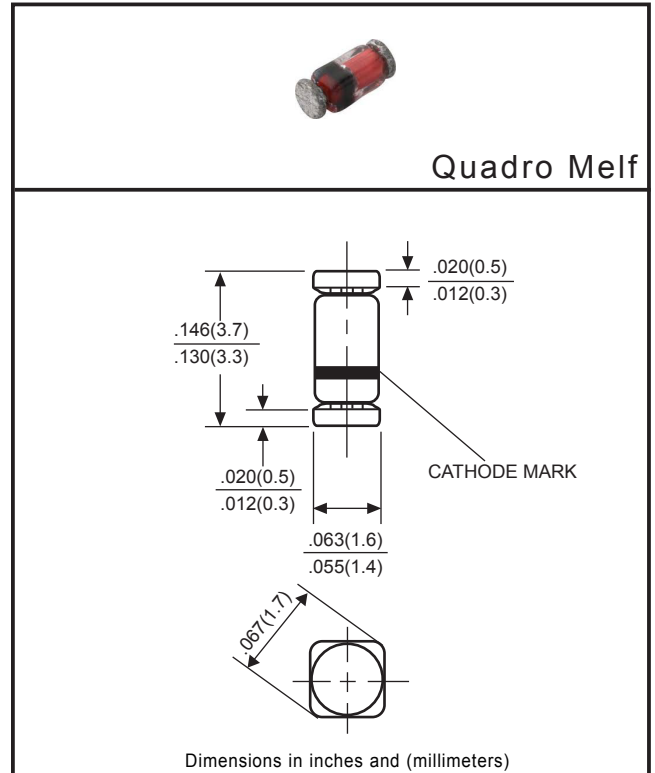

	SYMBOL	DLQ4148	DLQ4448	DLQ4150	DLQ4151	UNITS
Maximum Recurrent Peak Reverse Voltage	V _{RRM}	100	100	50	75	V
Maximum Average Forward Current	I _{FAV}	150	150	200	150	mA
Maximum Power Dissipation T _A = 25°C	P _{tot}	500	500	500	500	mW
Maximum Forward Voltage	V _F @I _F	1.0/10	1.0/100	1.0/200	1.0/50	V/mA
Maximum Reverse Current	I _R @V _R	5/75	5/75	0.1/50	0.05/50	µA/V
Maximum Reverse Recovery Time	t _{rr}	4.0	4.0	4.0	2.0	nS
Typical Thermal Resistance	R _{θJA}	300	350	350	350	°C/W
Typical Junction Capacitance	C _J	4.0	4.0	4.0	2.0	pF
Surge Forward Current, t < 1µs	I _{FSM}	2000	2000	4000	2000	mA
t < 1s		500				
Operating and Storage Temperature Range	T _J ,T _{STG}	-65 to +175				°C

NOTES: 1. C_J at V_R = 0, f = 1 MHz.
2. From I_F = 10mA to I_R = 1mA, V_R = 6Volts, R_L = 100Ω

RATING AND CHARACTERISTIC CURVES (DLQ4148)

FIG. 1
TYPICAL INSTANTANEOUS
FORWARD CHARACTERISTICS

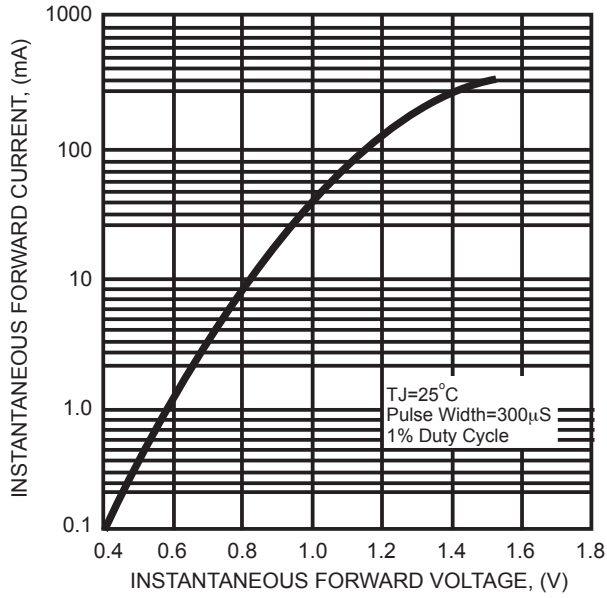

FIG. 2
TYPICAL FORWARD CURRENT
DERATING CURVE

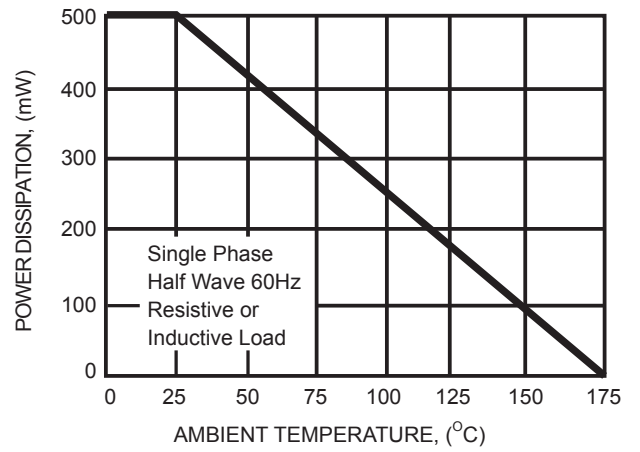
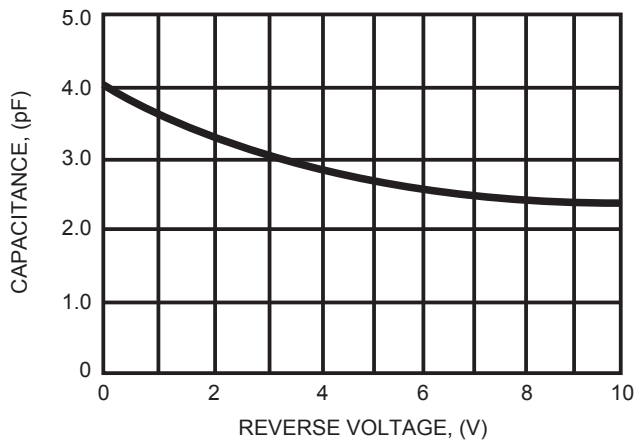

FIG. 3
TYPICAL JUNCTION CAPACITANCE



RATING AND CHARACTERISTIC CURVES (DLQ4448)

FIG. 1
TYPICAL INSTANTANEOUS
FORWARD CHARACTERISTICS

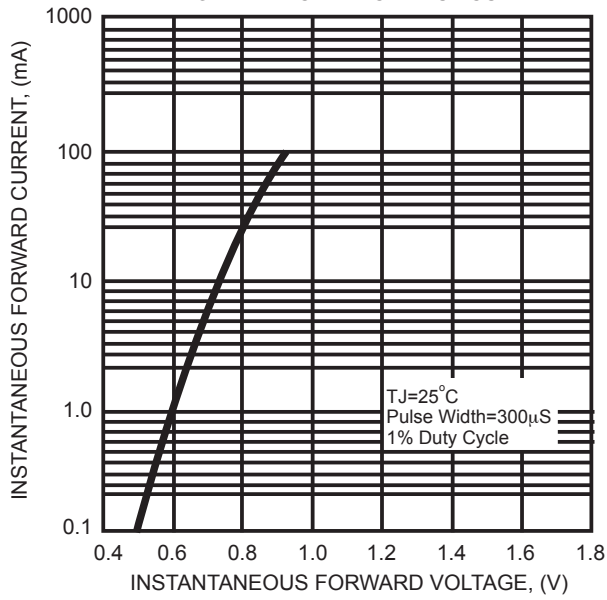

FIG. 2
TYPICAL FORWARD CURRENT
DERATING CURVE

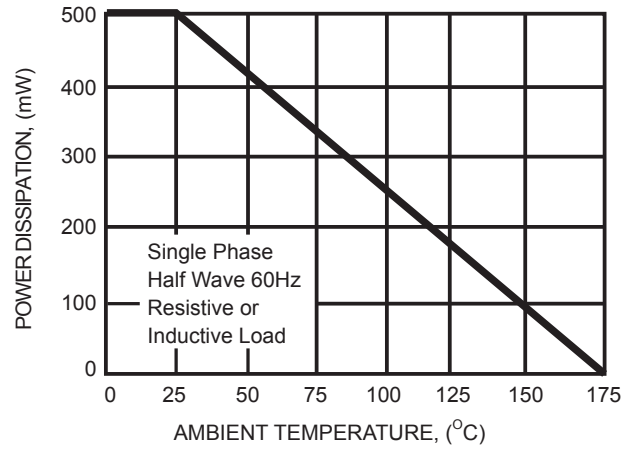
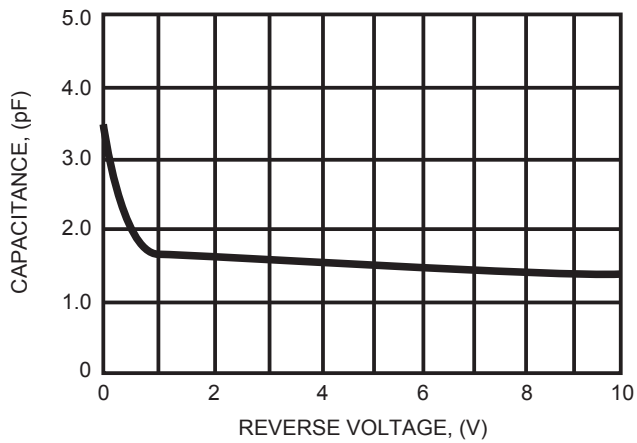

FIG. 3
TYPICAL JUNCTION CAPACITANCE



RATING AND CHARACTERISTIC CURVES (DLQ4150)

FIG. 1
TYPICAL INSTANTANEOUS
FORWARD CHARACTERISTICS

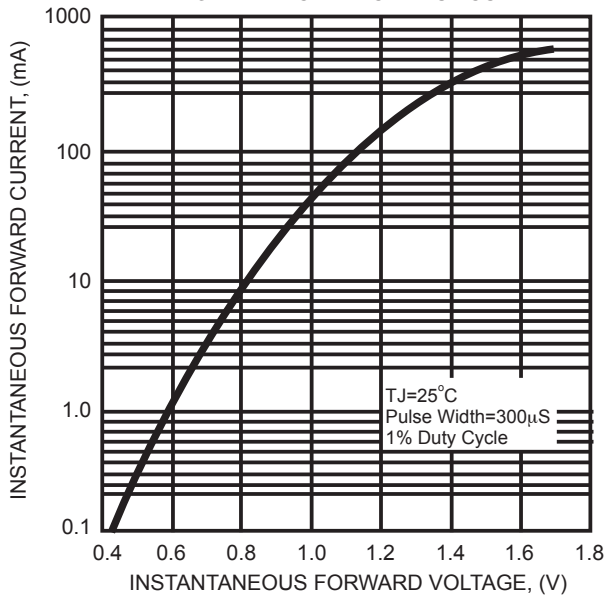

FIG. 2
TYPICAL FORWARD CURRENT
DERATING CURVE

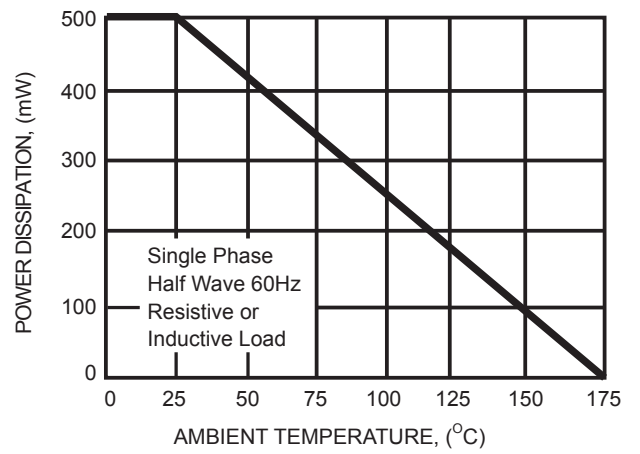
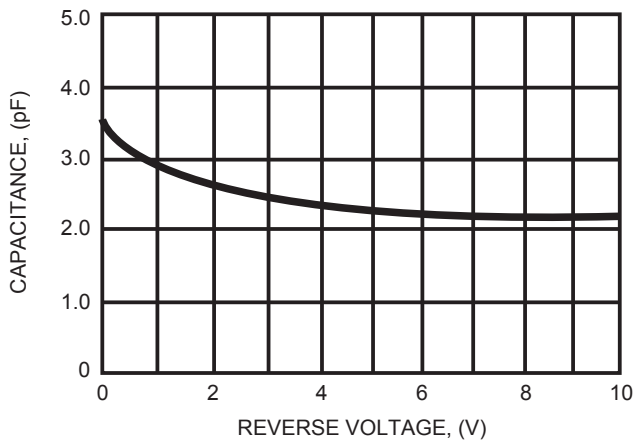

FIG. 3
TYPICAL JUNCTION CAPACITANCE



RATING AND CHARACTERISTIC CURVES (DLQ4151)

FIG. 1
TYPICAL INSTANTANEOUS
FORWARD CHARACTERISTICS

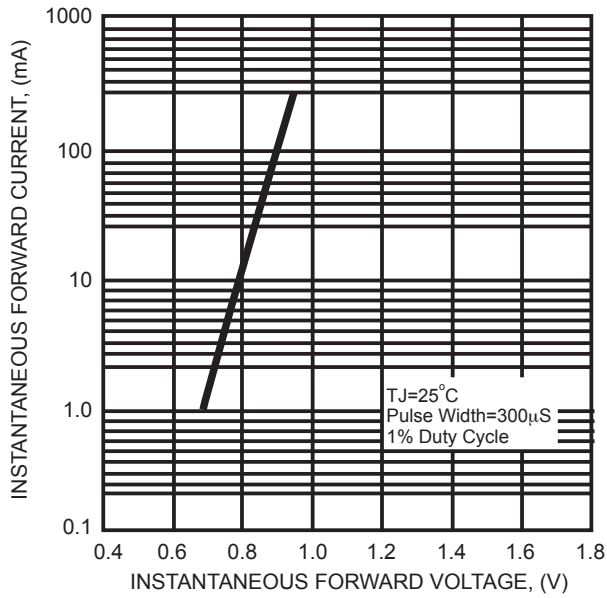

FIG. 2
TYPICAL FORWARD CURRENT
DERATING CURVE

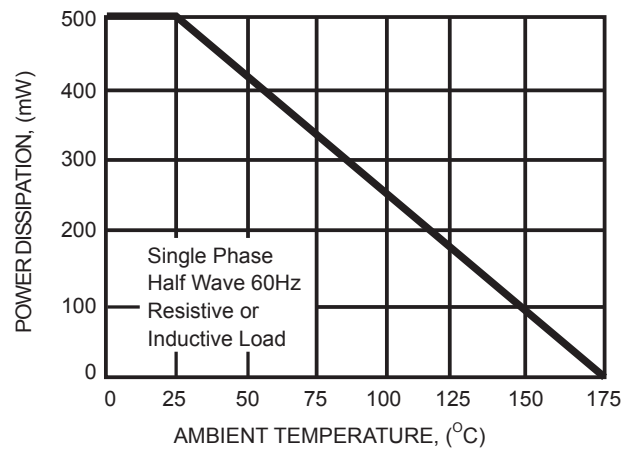
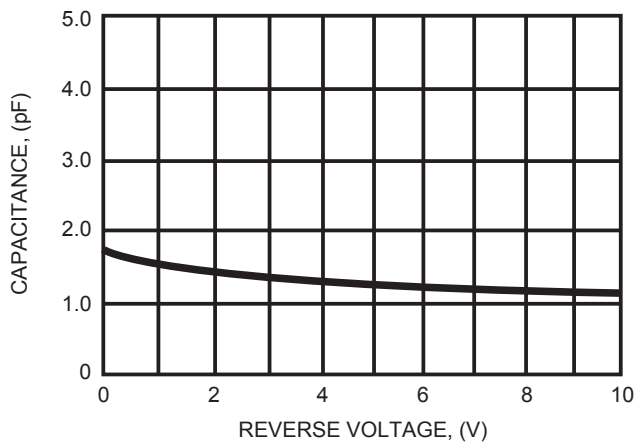

FIG. 3
TYPICAL JUNCTION CAPACITANCE



Disclaimer

Any Customer or user of this document or products described herein in such applications shall assume all risks of such use and will agree to hold **DC COMPONENTS** harmless against all damages.

DC COMPONENTS disclaims any and all liability arising out of the application or use of any product, including consequential or incidental damages. Statement regarding the suitability of products for certain types of applications are based on **DC COMPONENTS**'s knowledge of typical requirements that are often placed on **DC COMPONENTS** products in generic applications. Such statements are not binding statements about the suitability of products for a particular application. It is the customer's responsibility to validate that a particular product with the properties described in the product specification is suitable for use in a particular application.

DC COMPONENTS reserve the right to make modifications, enhancements, improvements, corrections or other changes without further notice to this document and any product described herein, and disclaim any and all liability for any errors, inaccuracies or incompleteness contained in any datasheet or in any other disclosure relating to any product. Parameters provided in datasheets and specifications may vary in different applications and performance may vary over time. All operating parameters, including typical parameters, must be validated for each customer application by the customer's technical experts. Product specifications do not expand or otherwise modify **DC COMPONENTS**'s terms and conditions of purchase, including but not limited to the warranty expressed therein.

Unless otherwise in writing, **DC COMPONENTS** products are intended for use as general electronic components in standard applications (eg: Consumer electronic, Computer equipment, Office equipment, etc.), and not recommended for use in a high specific application where a failure or malfunction of the device could result in human injury or death (eg: Aerospace equipment, Submarine cables, Combustion equipment, Safety devices, Life support systems, etc.)

Customers using or selling **DC COMPONENTS** products not expressly indicated for use in such applications do so at their own risk. If customer intended to use **DC COMPONENTS** standard quality grade devices for applications not envisioned by **DC COMPONENTS**, please contact our sales representatives in advance.



DC COMPONENTS CO., LTD.